

Low Voltage Control for the Liquid Argon Hadronic End-Cap Calorimeter of ATLAS

H.Brettel*, W.D.Cwienk, J.Fent, H.Oberlack,
P.Schacht

Max-Planck-Institut für Physik, Werner-Heisenberg-Institut,
Foehringer Ring 6, D-80805 Muenchen
brettel@mppmu.mpg.de

Abstract

The strategy of the ATLAS collaboration foresees a SCADA system for the slow control and survey of all sub-detectors. As software PVSS2 has been chosen and for the hardware links a CanBus system is proposed.

For the Hadronic End-caps of the Liquid Argon Calorimeter the control system for the low voltage supplies is based on this concept. The 320 preamplifier and summing boards, containing the cold front-end chips, can be switched on and off individually or in groups. The voltages, currents and temperatures are measured and stored in a database. Error messages about over-current or wrong output voltages are delivered.

I. DETECTOR CONTROL SYSTEM OF ATLAS

The slow control of detectors, sub-detectors and components of sub-detectors is realized by a so-called SCADA software, installed in a computer net. It is an industrial standard for Survey, Control And Data Acquisition. The product, installed at CERN, is "PVSS2" from the Austrian company "ETM".

Links between net nodes and hardware can be realized in different ways. Between the last node and the detector electronics a CanBus is recommended by the collaboration for the transfer of slow control signals and the survey of temperatures, supply voltages and currents (figure 1).

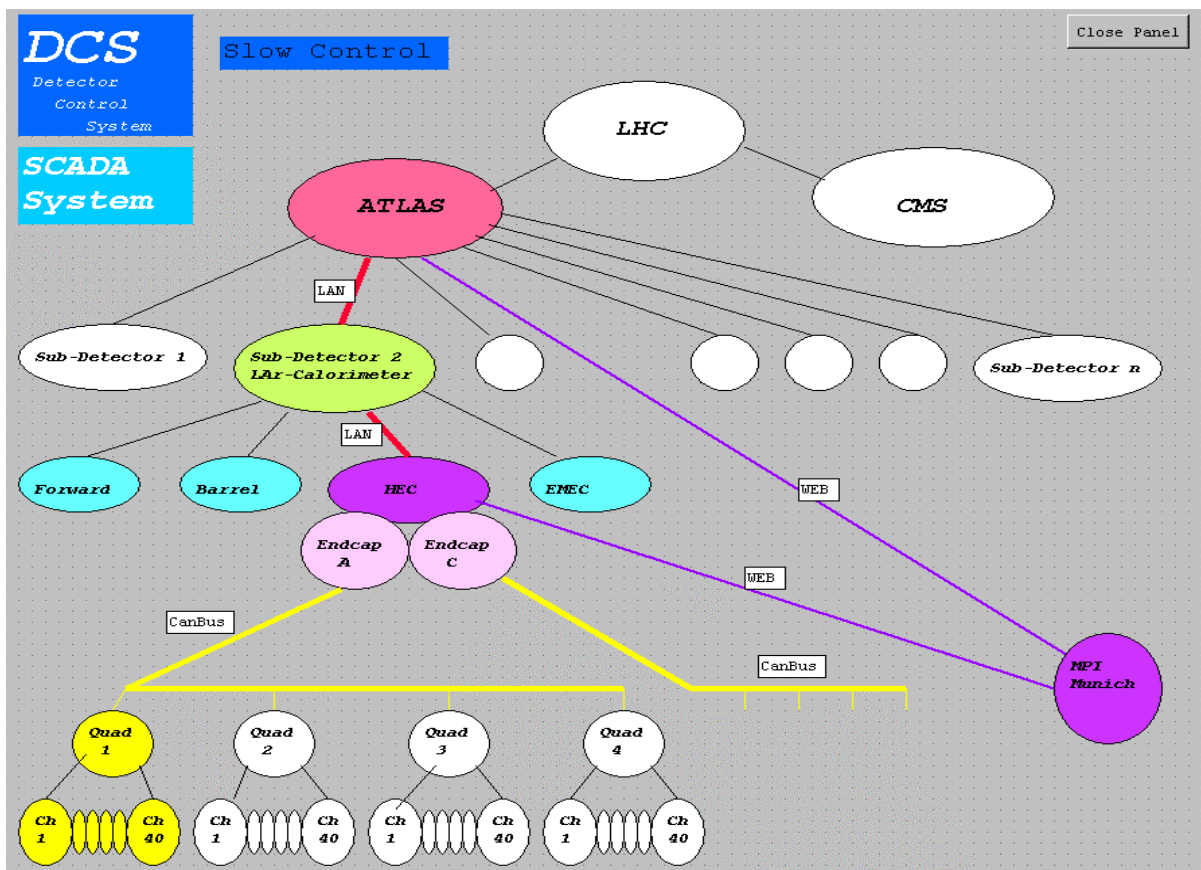

Figure 1: DCS detector control system (principle structure)

II. LOW VOLTAGE CONTROL OF HEC

A. System Overview

The supply voltages for the cold front-end electronics of the two Hadronic End-cap wheels are generated in 8 power boxes near the front-end crates and distributed to the 320 preamplifier- and summing boards inside the cryostats (see figure 3).

Graphical windows on a PC (figures 2 and 4), tailored to operators needs, offer complete individual control und survey of the 320 supply channels.

The application software in the PC is called a “PVSS2-project”. It establishes the link to the DCS net by an appropriate protocol. The exchange of information with the low voltage channels takes place via a CanBus by a CanOpen protocol. CAN is a very reliable bus system widely used by industry, for example in cars for motor management, brake activation etc.

At the ATLAS DCS the PC is bus master. The hardware interface board NICAN2 is controlled by the driver software OPC. CanBus slaves are offered by industry for different purposes. We use the ELMB from the CERN DCS group, which is tailored to our needs. It has 2 microprocessors inside, digital I/O ports, a 64-channel analog multiplexer and an ADC.

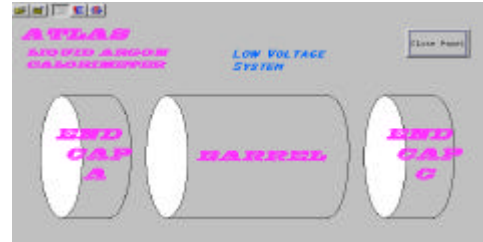

Figure 2: Liquid Argon Calorimeter

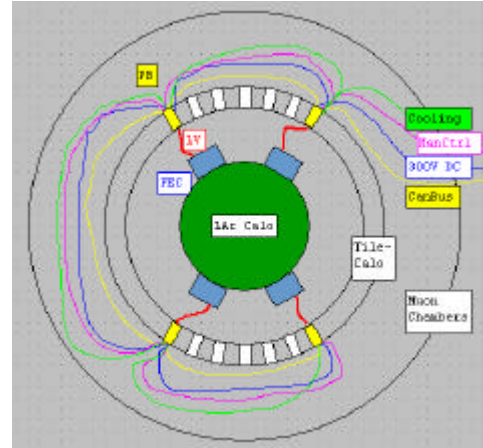

Figure 3: HEC low voltage system (one end-cap)

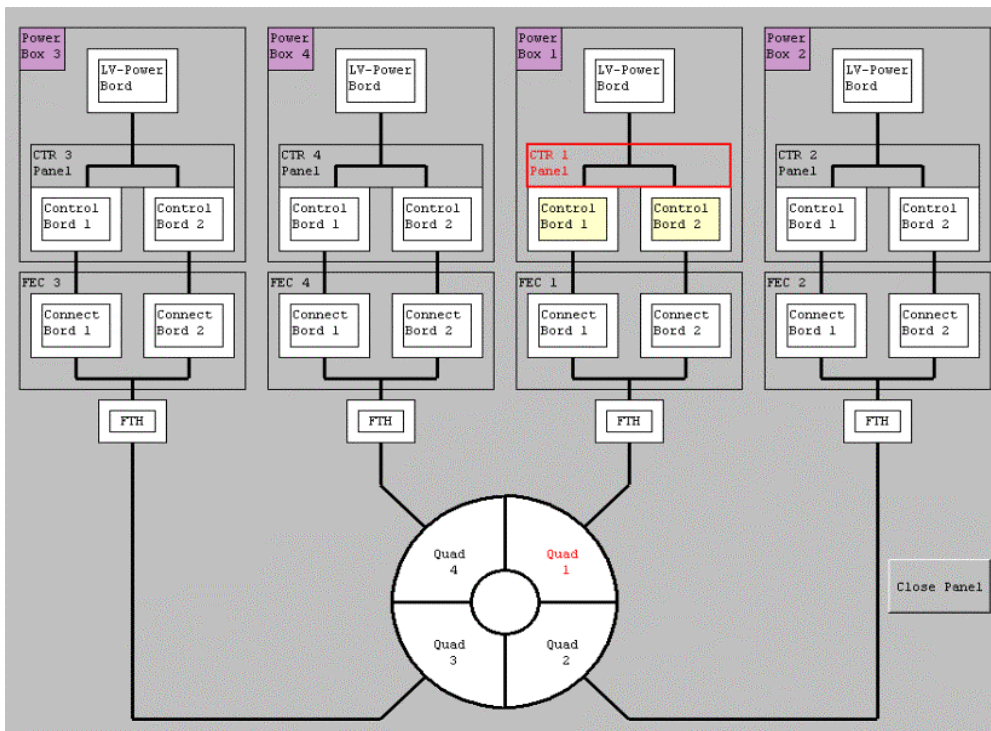

Figure 4: PVSS2 main panel, “LV CONTROL”

The panel displays the structure of the system. By mouse-click on items of this panel the operator can open other panels that show more details and offer full access to hardware components and the database (figures 5 and 6 at next page). To distinguish between different types of daughter panels, a colour code is applied: red signifies an action panel and violet a display of hardware details (mechanics, circuit diagrams).

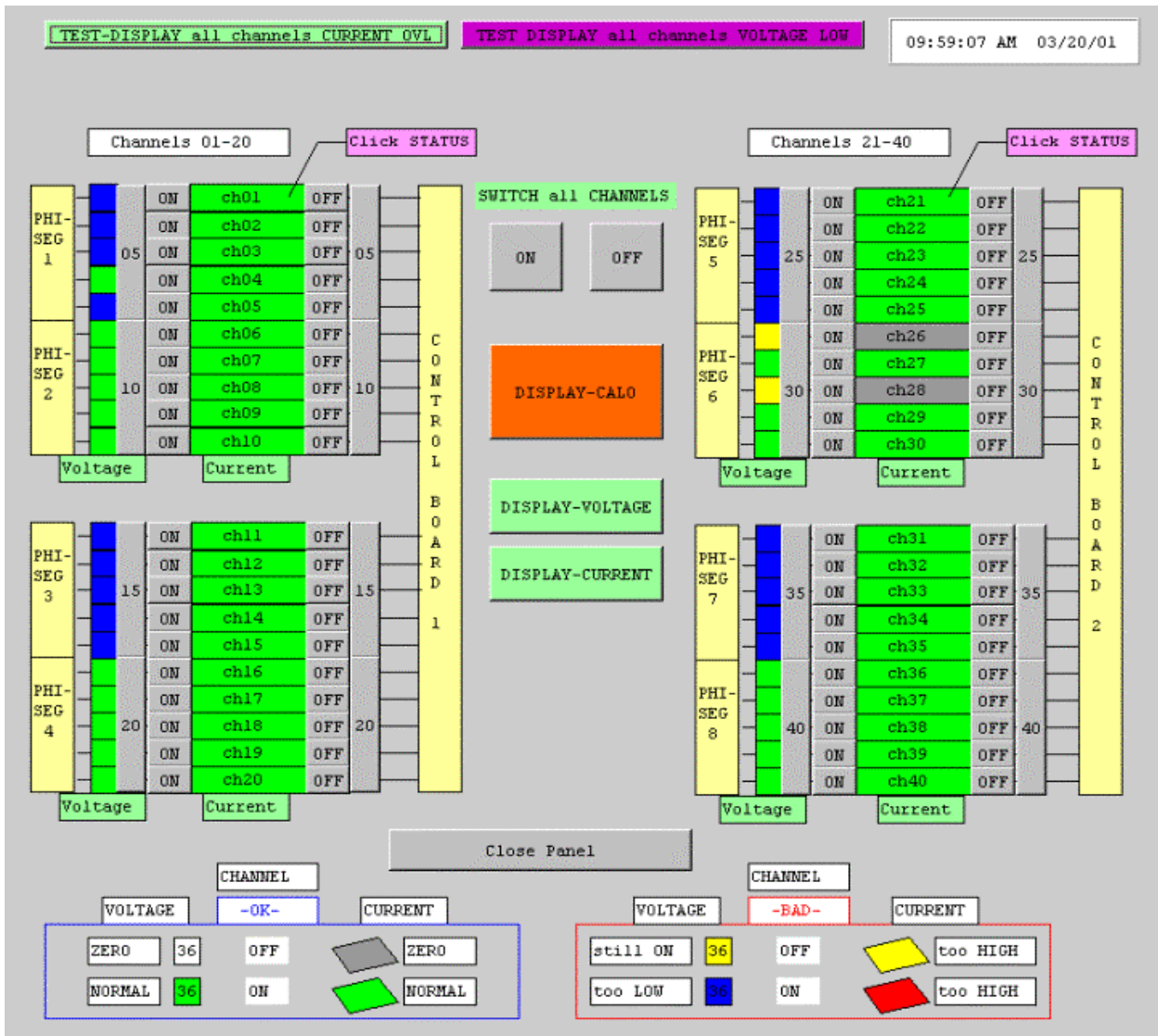

Figure 5: PVSS2 daughter panel “CHANNEL CONTROL”
 Colours are changed and animated (blinking) in case of fault conditions, like wrong voltage or excessive current.

B. Hardware

Each of the two HEC-wheels consists of 4 quadrants served by a feed-through with a front-end crate on top of it (figure 2). Each quadrant is equipped with 40 PSBs, (the preamplifier and summing boards, which contain the cold GaAs front-end chips). A related power box, delivers the low supply voltages. For each wheel 4 boxes are needed. They are mounted between the fingers of the Tile Calorimeter, about half a meter away from the front-end crates.

The input for a power box – a DC voltage in the range of 200 to 300V – is transformed into +8V, +4V and -2V at the 3 output lines by DC/DC converters and then split into 40 channels at two control boards (figure 7). There is an individual ON/OFF control and a fine adjustment of the three supply voltages for each PSB.

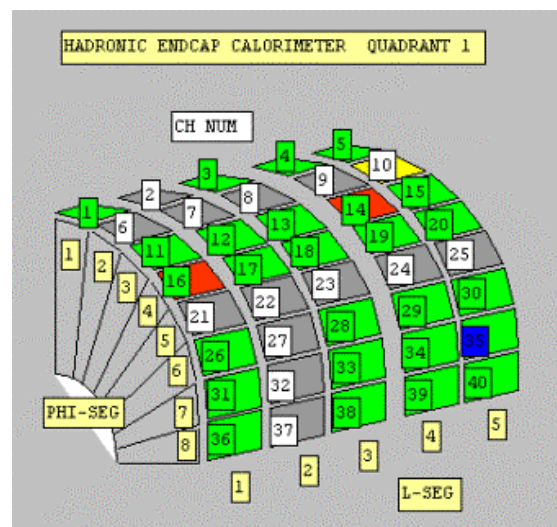

Figure 6: PVSS2 daughter panel “CALO QUADRANT”
 3-dimensional view with animated colours

1) Original design

We intended to use the integrated low voltage regulators L4913 and L7913 from STm. They should be mounted on the control boards inside the power boxes

together with FPGAs from QuickLogic, which contain the necessary digital control circuitry, and the ELMBs as interfaces to the CanBus. By this arrangement the cable connections to the power boxes could have been minimized.

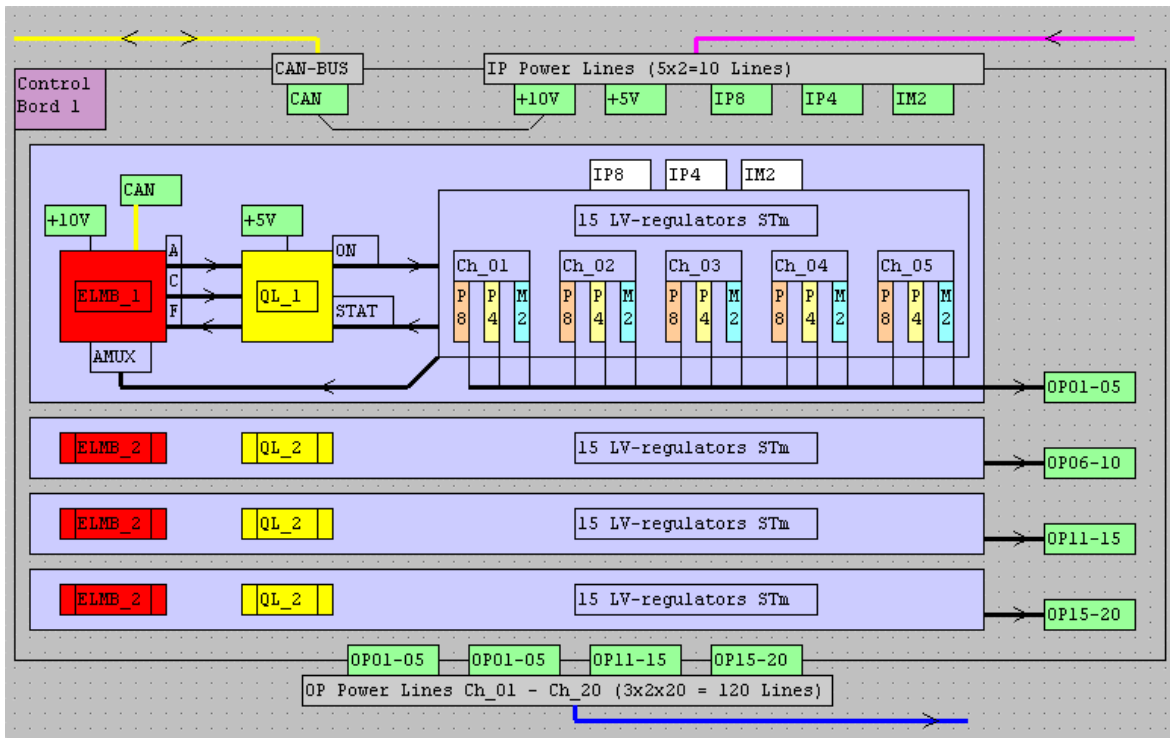

Figure 7: Low voltage control board (original design)

2) Actual problems

Meanwhile it turned out that the ELMBs are not as radiation hard as we had expected and cannot be mounted at the foreseen position.

The low voltage regulators from STm are confirmed to be radiation hard, but there seems to be still problems in the design or fabrication process.

So we have to envisage alternate solutions, at least during the present phase of design work. Concerning the ELMBs there is no other way than to place them outside the Myon chambers, but we would still like to apply the above mentioned regulators for reasons of small size and low cost.

3) Prototype designs

During the assembly of the wheels at CERN and for combined tests, existing power supplies will be used. Control boards, corresponding to the original plan but in non-radiation hard technology, are in preparation. ELMBs will be mounted on these boards. Instead of STm-regulators other products must be used and can be replaced later by types of final choice (STm or other radiation hard regulators).

Ongoing considerations about final solutions will result in a second version of control board with radiation hard components. The ELMBs, which will no more be mounted on the boards but far outside the power box, are connected by a multi wire cable. As a consequence of this arrangement an

array of analogue multiplexers is needed on the boards as well as much more complex logic in the FPGA.

4) Final Solutions

A) The American company "Modular Devices" is developing power supply boxes for EMEC under the direction of "BNL". As the units will be mounted between the fingers of the tile calorimeter, radiation hardness is mandatory. As primary choice we envisage to adopt this solution. Only the output voltages would be adjusted to the values required by HEC, and two control boards from MPI mounted additionally inside. The main disadvantages are relative high cost and the present uncertainty about the STm-regulators.

B) Therefore a second source is highly desirable. We are negotiating with the German company "GSG-Elektronik" near Munich, which is experienced in radiation hard electronics for space research. The company offered a design study and would be able to built prototypes in an acceptable time. Either one could apply big DC/DC converters (a certain number in parallel for redundancy), which deliver precisely the desired voltages, and then split the output into 40 channels with transistor switches in series, ore use for each channel a small DC/DC converter with remote on/off control. In any case there would be no need to have the problematic STm-regulators. The negative aspect of these approaches is, that the company would put the responsibility and actions for radiation tests to MPI.

5) Safety aspects

Temperature sensors are foreseen in the power boxes on each board as well as detectors for leaking cooling water. In case of a serious problem the main is switched off automatically.

The power supplies have a build-in over-voltage protection and the low voltage regulators (or the small DC/DC converters respectively) have a current limitation. The maximal current is adjusted to such a low value, that the wires in the feed-through cannot be damaged in case of a steady short circuit inside the cryostat. In addition, in case of an over-current, an error signal is delivered and all 3 regulators that belong to faulty channel are switched off immediately by the internal logic. Afterwards a detailed description of the problem is sent to the PC.

Under normal operating conditions the temperatures of the boards and the supply voltages and currents of all channels are registered regularly.

For the case that a computer or the bus itself would fail, an emergency control system is planned, independent of the CanBus. By remote switches in the measuring hut, the operator can switch off or on all channels simultaneously.

C. Software

As mentioned before, the control program is written in PVSS2, which is based on the ANSI C language. It has several graphics tools that help the programmer during the design phase.

A data point structure and a list of data points has to be established first. The so-called "Data Points" are variables in the program, where the information about all hardware items is stored. By the aid of a graphics editor, panels are designed for various purposes (displays, actions, diagrams). Symbols on panels are connected to control scripts (C-language). At runtime the automatically generated main program uses the scripts as subroutines.

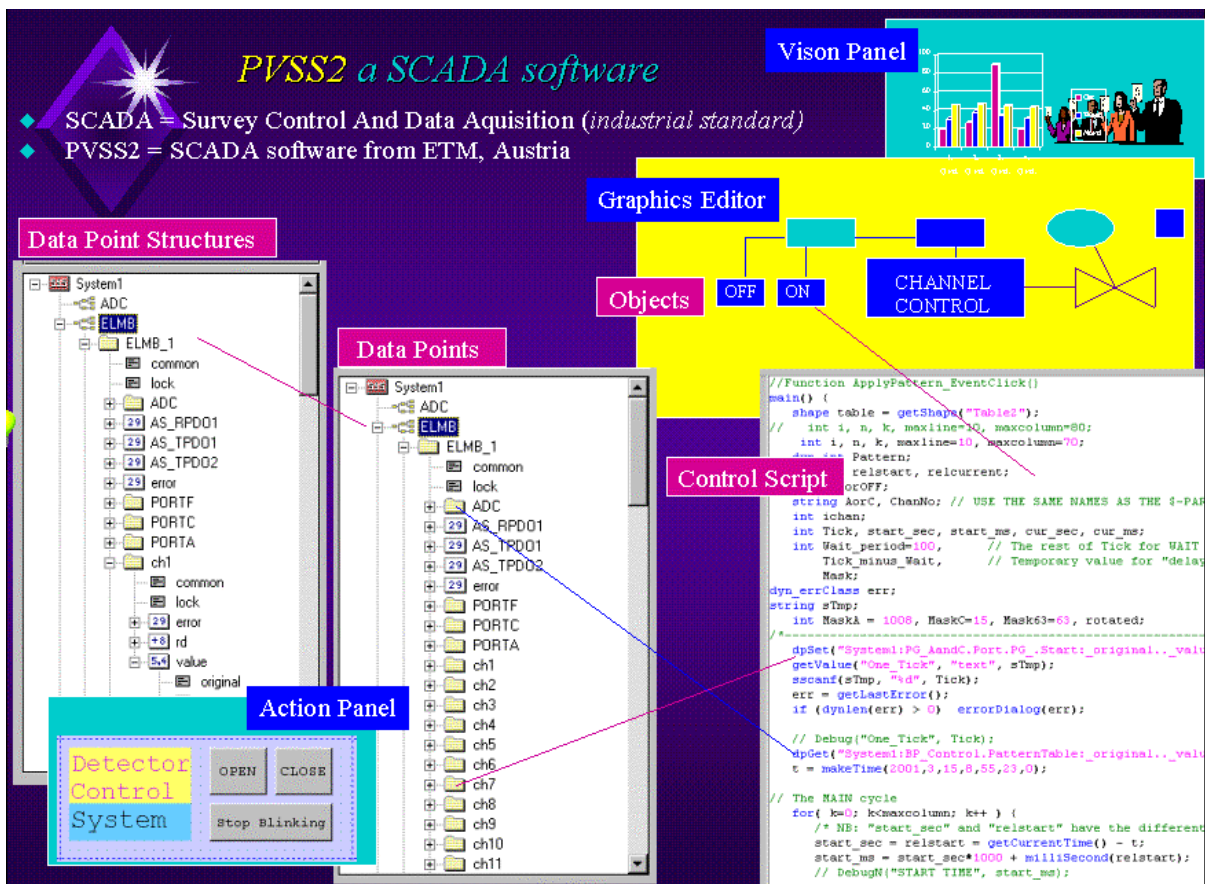

Figure 8: PVSS2, a SCADA software for slow control

D. Status of Development

Tests of substantial hard and software components have been carried out. The work on control boards is progressing. A link between a PVSS2 test program on a PC and an ELMB (via OPC, NICANII and CanBus) is operational.

We are gaining more and more experience with the PVSS2 software. Many examples of graphics panels and control scripts have been developed and are supposed to be the basis for the low voltage control program.

A decision about a second source of power boxes should be taken in the near future.