

The CMS Tracker front-end and control electronics in an LHC like beam test.

W.Beaumont^b, M.Bozzo^f, C.Civinini^d, J.Coughlan^k, F.Drouhin^h, P.Figueiredo^e, L.Fiore^c, A.Giassi^j,
R. Grabit^e, K.Gill^e, J.Gutleber^e, G.Hall^g, L.Latronico^f, C.Ljuslin^e, M.Loretiⁱ, C.Maazouzi^l,
A.Marchioro^e, **N.Marinelli**^{**g}, C.Paillard^e, T. Parthipan^k, P.Siegrist^e, L.Silvestris^{c,e}, I.Tomalin^k,
A.Tsirou^e, F. Vasey^e, P.G.Verdini^j, P.Walsham^g, B.Wittmer^a, A.Zghiche^{l,e}

** Corresponding author E-mail address: n.marinelli@ic.ac.uk

- (a) RWTH, I. Physikalisches Institut, Aachen, Germany
- (b) Universitaire Instelling Antwerpen, Antwerpen, Belgium
- (c) INFN, Sezione di Bari, Bari, Italy,
- (d) INFN, Sezione di Firenze, Firenze, Italy
- (e) CERN, 1211 Geneva 23, Switzerland
- (f) Università di Genova and INFN, Sezione di Genova, Genova, Italy
- (g) Blackett Laboratory, Imperial College, London SW7 2AZ, United Kingdom
- (h) Université de l'Haute Alsace, Mulhouse, France
- (i) INFN, Sezione di Padova, Padova, Italy
- (j) INFN, Sezione di Pisa, Pisa, Italy
- (k) Rutherford Appleton Laboratory, Didcot, OXON, OX11 0QX, United Kingdom
- (l) Institut de Recherches Subatomiques, IN2PS-CNRS Strasbourg, France

Abstract

A complete prototype of the CMS tracker read-out and control system has been built using components as close as possible to the final design. It is based on an amplifier and analogue pipeline memory chip (APV), analogue optical links transmitting at 40Ms/s and a VME mounted digitisation and data handling board (FED-PMC), supplemented by a control architecture based on FECs which set and monitor the components of the entire system. This system has been successfully operated for the first time under LHC like beam conditions in a 25ns structured beam provided by the SPS at CERN. The objective was primarily to test the synchronisation and pile-up effects in a high trigger rate environment and to examine the many issues involved in operating a complete readout and control system.

I. INTRODUCTION

The read-out and control system for the CMS Tracker is a complex and ambitious project, meant to cope with the extremely new and hostile conditions which will be encountered at the LHC p-p machine. The electronic challenges for the system are principally to ensure a low noise during the entire operational lifetime, along with an adequate bunch crossing identification, which is ultimately limited by the speed and amplitude of signals coming from the detectors as well as by electronics.

The analogue read-out is based on APV chips [1], equipped with a charge sensitive amplifier with a time constant of 50ns whose output voltage is sampled at

40MHz. Samples are stored in a pipeline memory for a time equal to the L1 trigger latency (about 3.2 μ s) and then processed, on the arrival of a trigger, by an analogue circuit which performs a weighed summation when the chip is operated in deconvolution mode.

The data are then transmitted by analogue optical links [2] to the counting room. The optical links use edge-emitting lasers operating at 1310nm wavelength, coupled to single mode fibres with 3 patch-panels and PIN photodiode arrays. The digitisation is performed by the Front End Driver, which in the test-beam version, (FED-PMC) is an 8 channel ADC on a PCI Mezzanine Card [3]. The digitised data are then sent to the main Data Acquisition System.

The timing and control path is separated from the readout path in order to ensure that control and monitoring are totally independent from the DAQ system. The Front End Controller module (FEC) [4] (at present in a PMC version) takes care of: -

- a) interfacing with the Timing, Trigger and Control system [5] and hence distributing the encoded clock and trigger signals to the front-end, and
- b) setting and monitoring via I²C protocols all the parameters (e.g. bias voltages on APVs, delays on PLLs, etc.) needed to operate the system.

The communication architecture in the slow control system is based on a 'token-ring' protocol, which connects the FEC to the Communication and Control Units (CCUs) and on a 'channel' protocol, which connects each CCU with the front-end chips.

All the components of the system can be tested (separately or partially assembled) in a laboratory, but there are questions which can only be answered in

realistic operational conditions. The main reasons for using an LHC-like beam can then be summarised in the following points: -

- a) the response of the front-end electronics and the subsequent effect on the overall quality of the data can only be fully evaluated by exposing the detectors to a structured beam;
- b) the CMS Tracker is meant to be a fully synchronous system and only an LHC-like beam provides suitable conditions to study and verify possible synchronisation procedures as well as to develop monitoring tools.

Furthermore the May test has offered the first opportunity to:

- a) integrate and test the whole optical link system, even if on a small scale as compared with the one which will be needed in CMS;
- b) integrate and test the whole Slow Control system.

II. MAY 2000 TEST SYSTEM DESCRIPTION

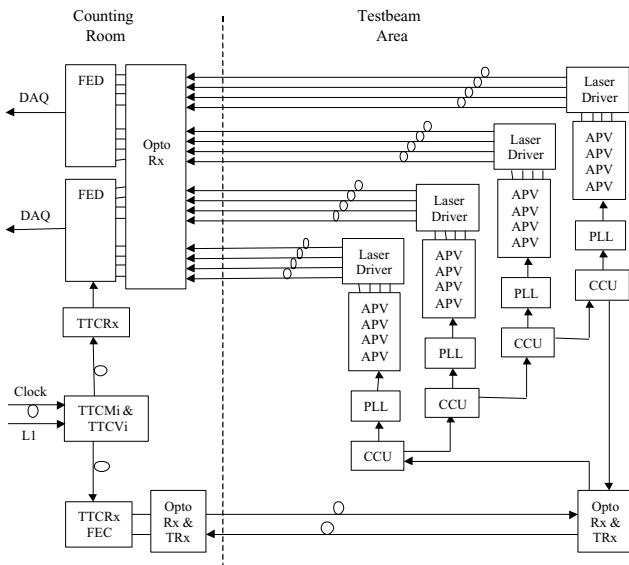

Figure 1: Schematic layout of the system installed in May 2000.

A. Timing and trigger

A TTC machine interface [5] crate, in the final version to be used in CMS, receives the 40MHz Clock and the 43KHz SPS Orbit signal from the Prevevissin Control Room. These signals are distributed via optical fibres to the LHCrx module interface where they are converted to electrical signals. The clock is encoded with the trigger signal by the TTCvi module and then sent to the FEC for final distribution to the front-end via a digital optical link. The trigger signal is provided by the coincidence of two photo-multipliers (3x3 and 3x6cm²) located along the beam line before the detectors.

B. Read-out and Control: Hardware

Four “standard” silicon strip detectors have been fully equipped and read out with four APV6s. Four 4-channel analogue optical links [6] were installed to transmit the data to the counting room. The optical links used prototype components, including 4-way laser packages and 4-way analogue laser driver chips. Data were transmitted along single-mode fibre ribbons, embedded in a prototype 96-way optical cable, having two (MT) connectorized breakpoints. The optical signals were converted to electrical ones via a prototype 4-way receiver. Two FED-PMC cards (16 channels) have been used to perform data capture and digitisation. Digitised data are then sent to the Central DAQ system.

Each detector module has been equipped with a CCU, used for decoding the clock and trigger signals as well as for the distribution of the I²C parameters to all the devices, and a PLL programmable delay unit [7] for clock regeneration and phase adjustment. The four CCUs were connected in a ring served by one FEC. Prototype digital optical links were used to transmit the digital signals at 80Mbit/s. Earlier measurements performed in the laboratory demonstrated that these optical links have a bit-error-rate of $<10^{-12}$. The schematic layout of the system installed for the May test is shown in Fig 1.

C. Control: Software

A multi-processor and multi-layered software architecture has been developed: a low level library running under the LynxOS operating system on dedicated VME CPU boards handles all accesses to the hardware through the FEC boards and includes a mechanism to lock the access to any front-end device. An intermediate library contains the primitives to build tasks, running on this VME CPU, that directly access the various CCU registers. The topmost software layer allows the users to directly access the registers of the various front-end devices via the VME processor with no need of any knowledge about the interconnecting hardware.

The values of the parameters need to be stored and traced back as a function of time. A database server, running on a standard PC, based on the commercial Oracle Database (DB) management system, has been developed. Data and commands from the database server are recognised, interpreted, dispatched to the appropriate tasks and subsequently downloaded in the hardware.

D. Read-out and DAQ: Software

The readout software is subdivided into three main parts, the Readout Unit (RU), the Run Controller (RC) and the Filter Unit (FU). The RU is a modular software package designed to read-out data from the

FEDs and to perform reformatting and error checking. It also executes ancillary tasks such as the initialisation of the back-end read-out hardware and message transfer between the read-out crates. Finally it writes the formatted data, spill by spill, to a Dual Port Memory, from where they are picked up by a remote Filter Unit through VME/MXI or Ethernet. At this stage the data fragments coming from different crates are assembled into spills, processed and stored in an object-oriented database ready for the offline analysis. Data taking is supervised by the RC which, at each start of run, initialises all the RU tasks, and also communicates with the data base server so that all the I²C parameters can be downloaded in the front-end hardware. In parallel with the main DAQ system a data spy channel has been set up, aiming to perform basics tests on the quality of the data and to perform and check the synchronisation.

III. BEAM STRUCTURE

A 25ns structured pion beam ($10^6 \pi/\text{spill}$) has been provided by the SPS at CERN. A train of 84 bunches, spaced by 25ns, is delivered every $23\mu\text{s}$ (43kHz SPS revolution frequency) over a spill duration of about 2s.

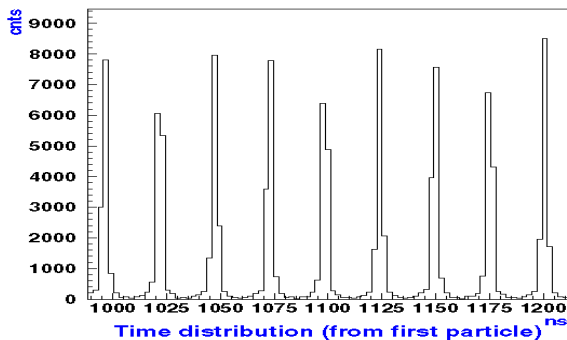

Figure 2: 25ns beam structure.

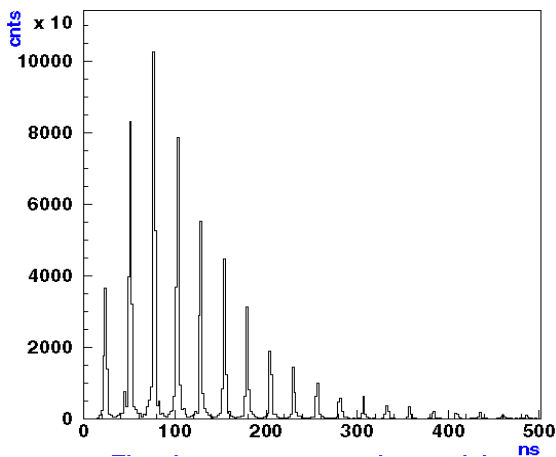

Figure 3: Distribution of the time difference between full bunches

In order to confirm that the test was carried out under the expected LHC-like conditions, a beam monitoring system, based on a multi-hit TDC has been set-up with the purpose of measuring the time distributions of the particles in the trains and the bunch width [8]. The 40MHz structure has been observed clearly as shown in Fig. 2.

The distribution of time between full bunches (containing at least one particle) shows that intervals of 3 bunches are favoured, being present in 17% of the cases, as shown in Fig.3. This feature makes the beam adequate to study pile-up effects.

The width of a single bucket, when measured in a high rate pion beam, is a broad distribution (see Fig.4) which receives contributions both from bunches containing a single particle and bunches containing more than one particle. The latter situation occurs in 74% of the cases as demonstrated by correlating the time measurement with the pulse height measured in the ADCs connected to the counters.

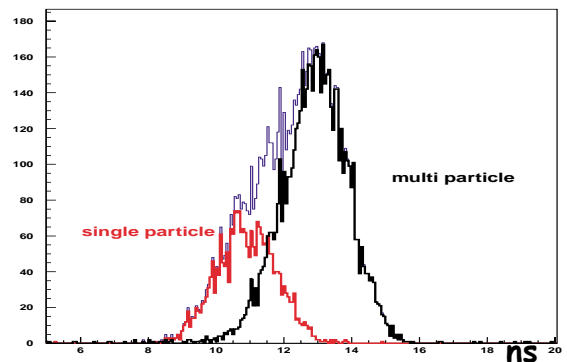

Figure 4: Distribution of the arrival times of particles with respect to the 40MHz machine clock in a pion beam. Bunches with single and multiple particles are present.

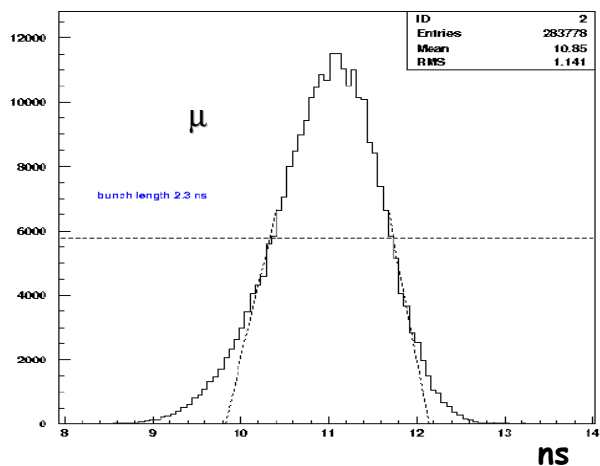

Figure 5: Distribution of the arrival times of particles with respect to the 40MHz clock in a $10^4 \mu/\text{spill}$ beam.

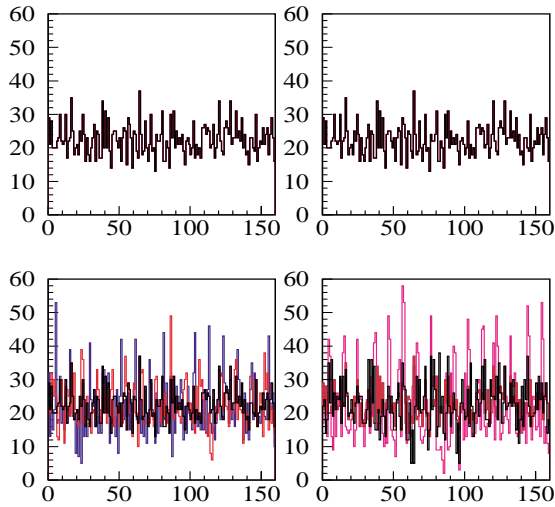

Figure 7: Distribution of the cell number in the APV pipeline which has been triggered. This number ranges from 0 to 159 in the APV6. The four plots are obtained from the 4 APVs on each module. Each plot is the superimposition of 4 histograms, one per APV. In the first 2 modules (upper plots) the APVs are clearly synchronous while in the other two modules, two APVs each went out of synchronicity.

A number of runs were taken with a pion beam in ‘peak’ mode, forcing the physical triggers to be spaced by 75ns (‘1001’ type). Trigger filters protected the APVs against overflows and hence errors in the pipeline. The ‘1001’ trigger sequence produces ‘back-to-back’ frames i.e. the APV output response to two triggers occurring within 7 μ s consists of two data frames with no gap in between. The ‘1001’ sequence was meant to study the overall performance of the read-out electronics and the effect of the pile-up on the S/N ratio. Events with particles separated by 75ns have been identified in the off-line analysis but the statistics collected in this first test are too low to give an accurate quantitative measurement [9].

The correlation between the position of the hits in three of the detectors has been studied in these runs. An entry is made in the histograms shown in Fig.8 for the position of clusters in any pair of the three detectors. The first and second triggers are analysed separately and no significant differences are observed neither in the number of entries nor in the value of the correlation.

VII. CONCLUSIONS

A first test has been performed on a full prototype of the CMS Tracker read-out and control electronics chain. It has been operated in a 25ns structured beam and the primary goal of integrating all the components,

most of them very close to their final versions, has been reached very successfully.

In order to tackle problems such as the control of the entire system or the time alignment, tools aiming to make procedures of this kind automatic have been developed. These can be improved in the future when a bigger system will undergo the same kind of tests.

The data collected in various conditions have only been partially studied and the off-line analysis is still on-going; the main result obtained so far is that the synchronisation of the system has been successfully achieved and that we are confident we are able to identify correctly particles coming three time-slots apart.

Experience has been gained of dealing with what is a complex system and a special beam environment.

Future tests of this kind on larger systems will be of vital importance for the success of the CMS Tracker.

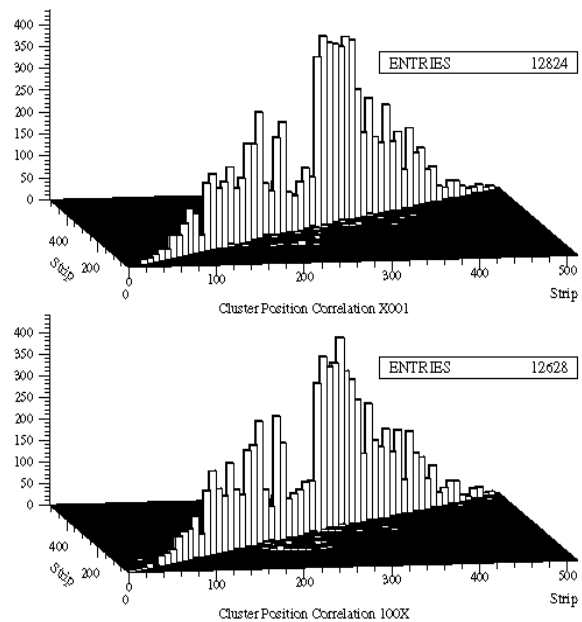

Figure 8: Correlation between hits in any two of three modules on the beam line in ‘1001’ trigger conditions. Upper and lower plots show the correlation measured in the first and second trigger respectively.

VIII. ACKNOWLEDGEMENTS

We would like to thank the CMS Tracker Collaboration for its support. We thank Mark Raymond

at Imperial College and Marcus French at RAL for their suggestions about the APV operation.

IX. REFERENCES

[1] 'The APV6 Readout Chip for CMS Microstrip Detectors', M. Raymond *et.al.*, Contributed Paper to the LEB Conference 1997, London.

[2] 'Project status of the CMS Tracker optical link', F. Vasey *et.al.*, Contributed paper to the LEB Conference 2000, Cracow

[3] 'A PMC based ADC card for CMS Tracker Readout', J. Coughlan *et.al.*, Contributed paper to the LEB Conference 1999, Snowmass, CERN/LHCC/99-33.

[4] 'A system for timing distribution and control of front end electronics for the CMS Tracker', A. Marchioro *et.al.*, Contributed paper to the LEB Conference 1997, London, CERN/LHCC/97-60.

[5] 'LHC machine timing distributions for the experiments', B. Taylor, RD12 Collaboration, Contributed paper to the LEB Conference 2000, Cracow.

[6] 'A 4-channel parallel analogue optical link for the CMS Tracker', F. Vasey *et.al.*, Contributed paper to the LEB Conference 1998, Rome, CERN/LHCC/98-36.

[7] 'A PLL-delay ASIC for clock recovery and trigger distribution in the CMS Tracker', A. Marchioro *et.al.*, Contributed Paper to the LEB Conference 1997, London, CERN/LHCC/97-60.

[8] 'A beam monitoring system for the SPS extracted 25ns bunched beam', M. Bozzo *et.al.*, CMS note in preparation.

[9] N. Marinelli, P. Walsham, CMS note in preparation.